

**APLICAÇÃO**

Transporte de produtos ou materiais industriais. Produtos alimentícios, carne de aves, suínos e bovinos in natura ou industrializados, pescados, frutas, vegetais, garrafas, enlatados, caixas plásticas e de papelão, etc.

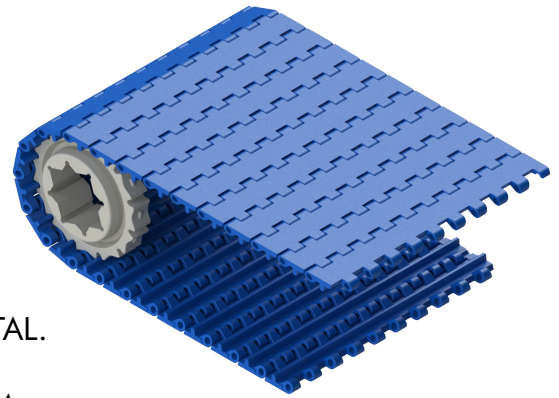

**DADOS GERAIS**

Termoplástico injetado em PP, PEAD, NYLON e POLIACETAL. Superfície lisa, com larguras de até 603 mm, podendo variar de acordo com a tabela de **PADRÕES DE LARGURA**.

**ESPECIFICAÇÕES**

(A) Passo	25,4 mm
(B) Espessura	9 mm
(C) Espessura	4,5 mm
Vazão	0,00%(Zero)
Ø Vareta	4,70 mm

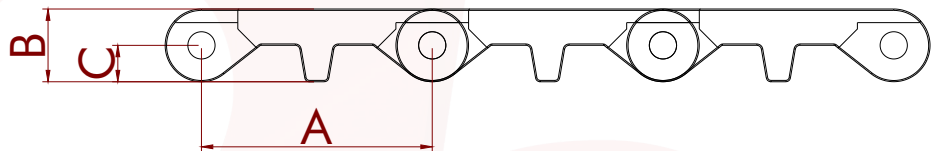

**DADOS DA ESTEIRA**

Material	Temperatura de trabalho °C	Capacidade de carga Kg/m*	Peso da esteira (Kg/m²)	Coefficiente de atrito	Cores padrões
PP	10 à 100	1875	5,3	0,15	●●●○
PEAD	-50 à 20	1500	5,7	0,13	●○
POLIACETAL	-50 à 120	2450	7,6	0,13	●●○
NYLON	5 à 120	2175	6,5	0,25	●●○

\*Capacidade de carga em relação a metros de largura.

**PADRÕES DE LARGURA (VARIAÇÃO DE + OU - 2MM)**

Material	Largura mínima (mm)	Incremento de largura (mm)	Larguras (mm)					
PP	49,9	9,98	99,8	199,6	299,4	399,2	499	598,8
POLIACETAL/PEAD	49,75	9,95	99,5	199	298,5	398	497	597
NYLON	50,25	10,05	100,5	201	301,5	402	502,5	603

OBS: Para larguras diferentes dos padrões acima, consultar com a Engenharia da BUMERANGUE.



**VISTA DO MÓDULO**

*Vista superior*

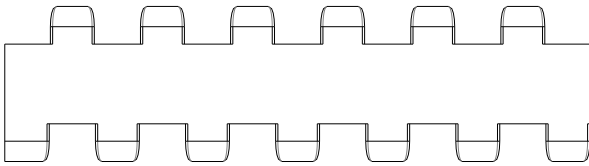

*Vista inferior*

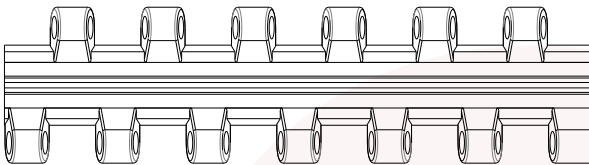

*Vista lateral*



**ENGRENAGENS**

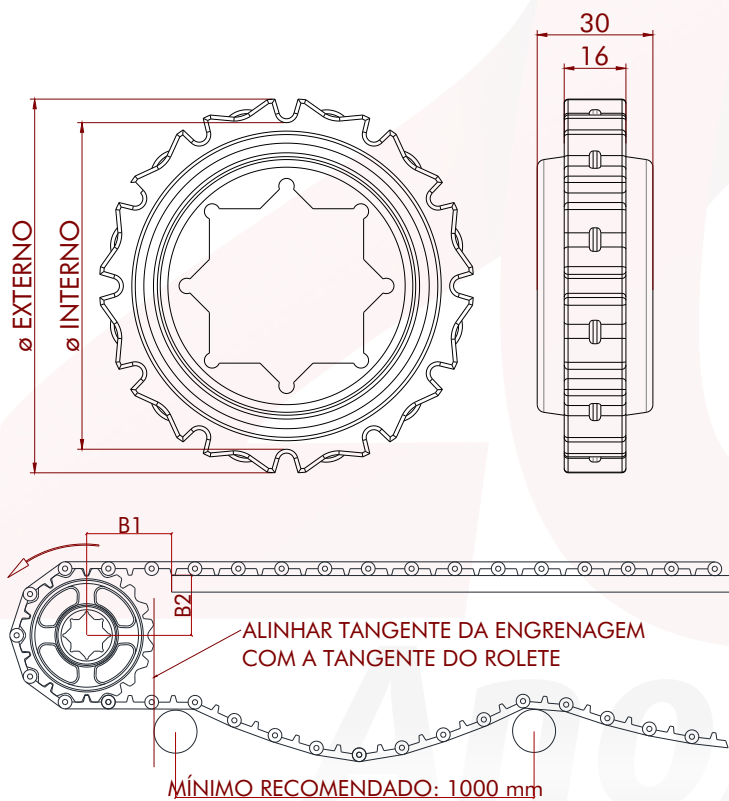

	EZ12R	EZ20R
Nº de Dentes	12	20
Ø Primitivo (mm)	100,3	162,85
Ø Interno (mm)	85	144
Ø Externo (mm)	97	155
Furo do eixo (mm)	38,1 / 40	38,1 / 40
Material	Acetal	Acetal
B1 (mm)	55	80
B2 (mm)	45	76

OBS: Para tamanhos diferentes dos padrões acima, consultar com Engenharia da BUMERANGUE.

**ACESSÓRIOS**

**Talisca reta**

(A) Altura	10 a 80 mm
(B) Espessura	9 mm
(C) Passo	25,4 mm
(D) Largura do módulo	200 mm

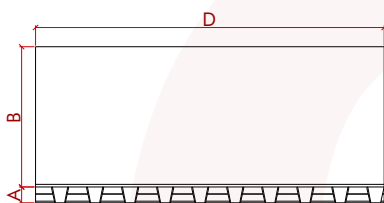
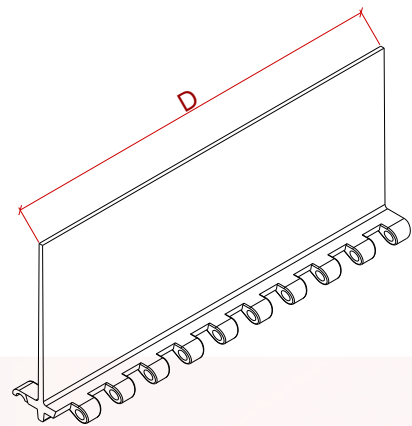
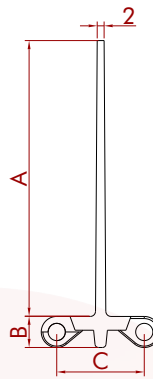

MÓDULO

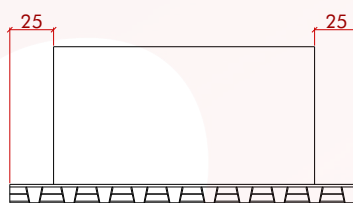

RECUO LATERAL FREZADO

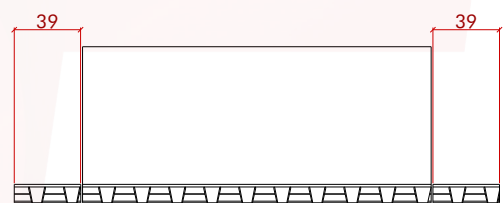

RECUO LATERAL COM MÓDULO SEPARADO

**Talisca concha**

(A) Altura	50 mm
(B) Espessura	9 mm
(C) Passo	25,4 mm
(D) Largura do módulo	400 mm

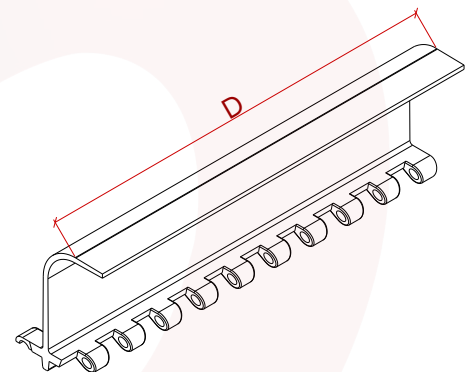
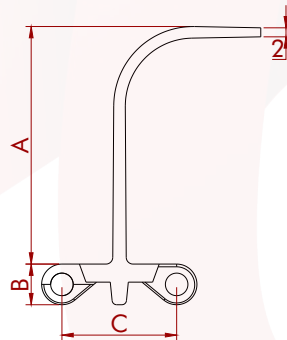

**Aba lateral 25x50**

(A) Altura	50 mm
(B) Passo	25,4 mm
(C) Largura	58 mm

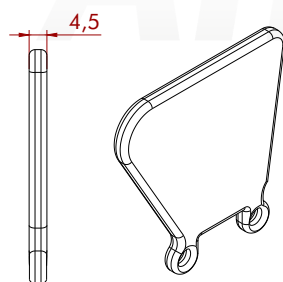
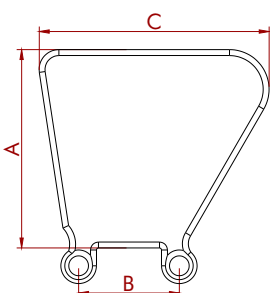

**Aba lateral 25x25**

(A) Altura	25 mm
(B) Passo	25,4 mm
(C) Largura	51 mm

