

APLICAÇÃO

Transporte de produtos ou materiais industriais. Produtos alimentícios, carne de aves, suínos e bovinos in natura ou industrializados, pescados, frutas e vegetais, garrafas e frascos, caixas plásticas e de papelão, enlatados, detectores de metais, entrada e saída de túneis de congelamento, etc.

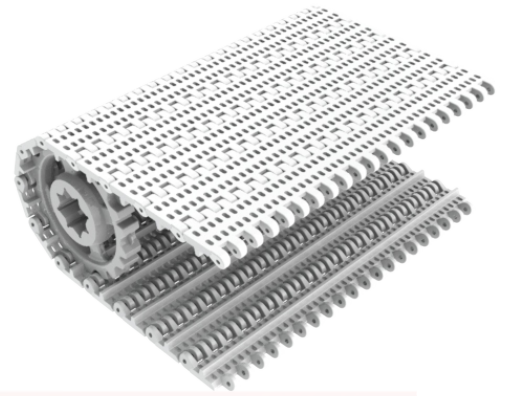

DADOS GERAIS

Termoplástico injetado em PP, PEAD, NYLON e POLIACETAL. Superfície vazada, com larguras de até 600 mm, podendo variar de acordo com a tabela de PADRÕES DE LARGURA.

ESPECIFICAÇÕES

(A) Passo	50,8 mm
(B) Espessura	16 mm
(C) Espessura	8 mm
Vazão	16,0%
Ø Vareta	5,80 mm

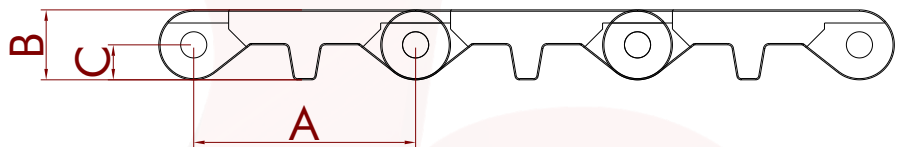

DADOS DA ESTEIRA

Material	Temperatura de trabalho °C	Capacidade de carga Kg/m*	Peso da esteira (Kg/m²)	Coefficiente de atrito	Cores padrões
PP	10 à 100	2500	6,9	0,15	● ● ● ●
PEAD	-50 à 120	2000	6,35	0,13	● ● ● ●
POLIACETAL	-50 à 120	3250	10,2	0,13	● ● ● ●
NYLON	5 à 120	2900	8,4	0,25	● ● ● ●

*Capacidade de carga em relação a metros de largura.

PADRÕES DE LARGURA (VARIAÇÃO DE + OU - 2MM)

Material	Largura mínima (mm)	Incremento de largura (mm)	Larguras (mm)					
			100	200	300	400	500	600
PP/NYLON	45	9,09	100	200	300	400	500	600
POLIACETAL/PEAD	44.5	9,01	99,1	198,2	297,2	396,4	495,5	595

OBS: Para larguras diferentes dos padrões acima, consultar com a Engenharia da BUMERANGUE.



VISTA DO MÓDULO

Vista superior

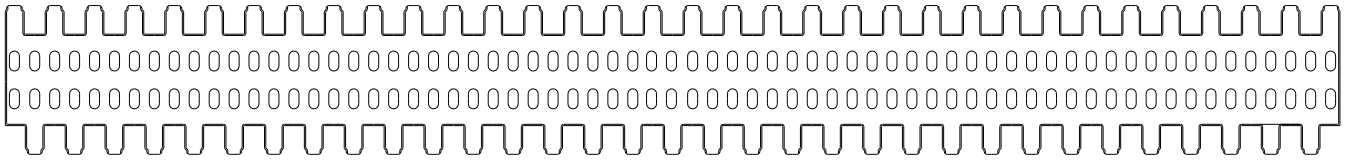

Vista inferior

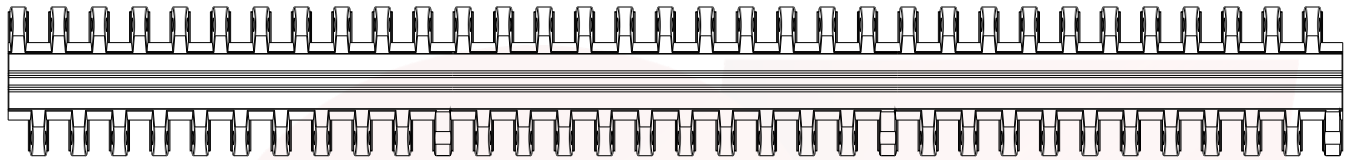

Vista lateral



ENGRENAGENS

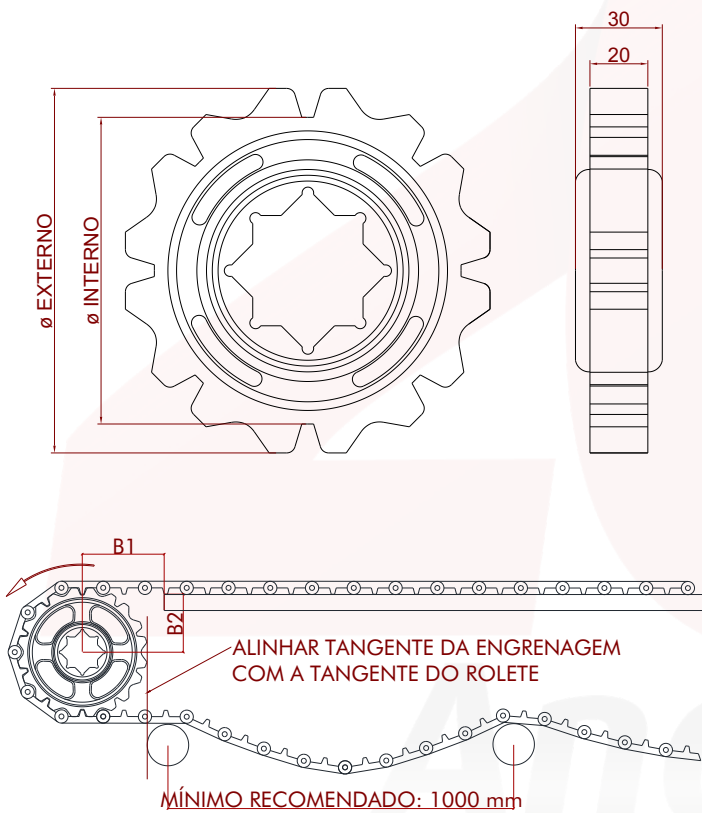

	EZ08R	EZ10R Bipartida	EZ12R
Nº de Dentes	08	10	12
Ø Primitivo (mm)	130	169	194
Ø Interno (mm)	103	144	171
Ø Externo (mm)	125,24	161,60	193,08
Furo do eixo (mm)	38,1 / 40	38,1 / 40	38,1 / 40
Material	Acetal	Acetal	Acetal
B1 (mm)	70	80	98
B2 (mm)	58	75	95

OBS: Para larguras diferentes dos padrões acima, consultar com Engenharia da BUMERANGUE.

ACESSÓRIOS

Talisca reta

(A) Altura	200 mm
(B) Espessura	16 mm
(C) Passo	50,8 mm
(D) Largura do módulo	600 mm

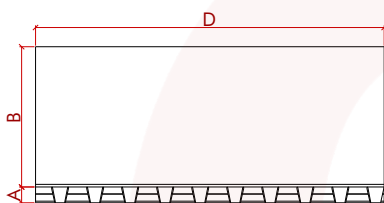
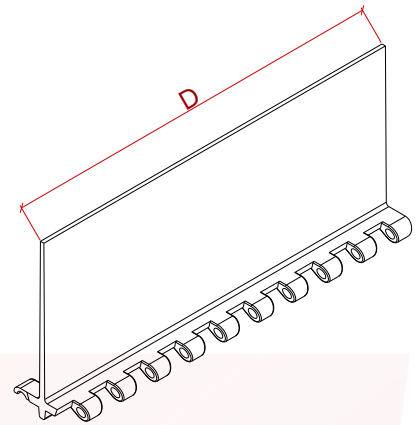
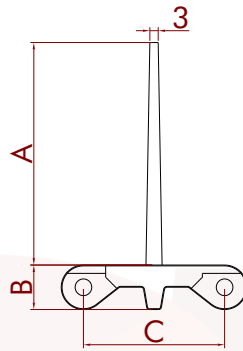

MÓDULO

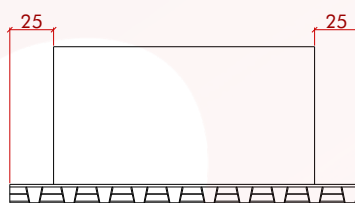

RECUO LATERAL FREZADO

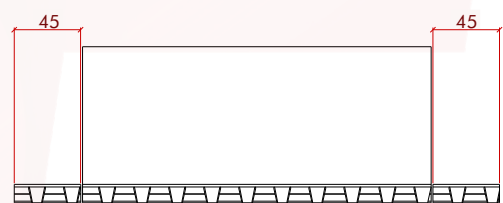

RECUO LATERAL COM MÓDULO SEPARADO

Talisca concha

(A) Altura	80/100 mm	150 mm
(B) Espessura	16 mm	16 mm
(C) Passo	50,8 mm	50,8 mm
(D) Largura do módulo	600 mm	200 mm

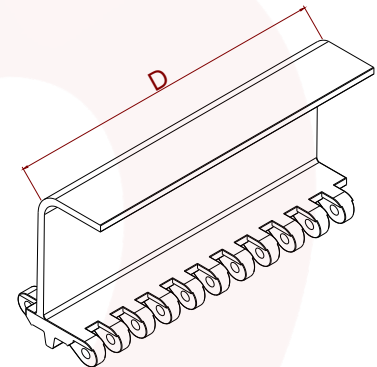
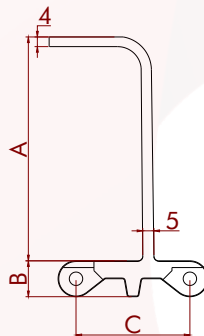

Aba lateral 50x80

(A) Altura	80 mm
(B) Passo	50,8 mm
(C) Largura	110 mm

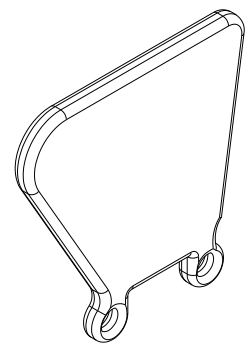
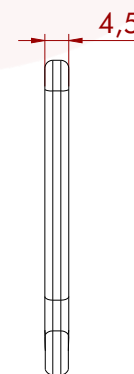
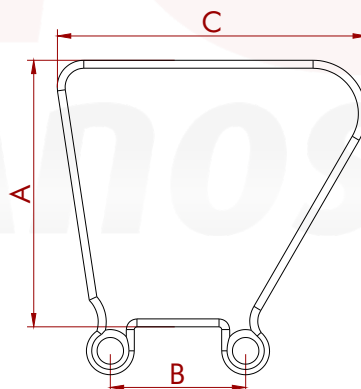

Aba lateral 50x100

(A) Altura	100 mm
(B) Passo	50,8 mm
(C) Largura	122 mm

